

## Thyristor-Thyristor Module, 25 Amps

**Features**

- Improved glass passivation for high reliability
- Exceptional stability at high temperatures
- High di/dt and dv/dt capabilities
- Low thermal resistance



Voltage Ratings ( $T_A = 25^\circ\text{C}$ , unless otherwise noted)					
Type number	Voltage Code	$V_{RRM}$ , Maximum repetitive peak reverse voltage (V)	$V_{RSM}$ , Maximum non-repetitive peak reverse voltage (V)	$V_{DRM}$ , Maximum repetitive peak off-state voltage (V)	$I_{RRM}$ , Maximum reverse leakage current @ $T_{JMAX}$ (mA)
NTT27	60	600	700	600	max. 5
	80	800	900	800	
	100	1000	1100	1000	
	120	1200	1300	1200	
	140	1400	1500	1400	
	160	1600	1700	1600	
	180	1800	1900	1800	

Electrical Characteristics ( $T_A = 25^\circ\text{C}$ unless otherwise noted)			
Parameter	Symbol	Values	Units
Maximum average forward current @ $T_J = 85^\circ\text{C}$	$I_{T(AV)}$	25	A
Maximum average RMS forward current	$I_{T(RMS)}$	40	A
Maximum non-repetitive surge current	$I_{TSM}$	550	A
Maximum $I^2t$ for fusing	$I^2t$	1500	$\text{A}^2\text{s}$
Forward voltage drop	$V_{TM}$	max. 1.7	V
Critical rate of rise of on-state current	di/dt	max. 150	$\text{A}/\mu\text{s}$
Critical rate of rise of off-state voltage	dv/dt	max. 1000	$\text{V}/\mu\text{s}$
Gate current required to trigger	$I_{GT}$	min. 150	mA
Gate voltage required to trigger	$V_{GT}$	min. 3	V
Maximum holding current	$I_H$	100	mA
Maximum latching current	$I_L$	250	mA
Isolation voltage	$V_{ISO}$	3000	V

Thermal & Mechanical Specifications ( $T_A = 25^\circ\text{C}$ unless otherwise noted)			
Parameter	Symbol	Values	Units
Operating junction temperature range	$T_J$	-40 to +125	$^\circ\text{C}$
Storage temperature	$T_{stg}$	-40 to +125	$^\circ\text{C}$
Thermal resistance, junction to case	$R_{th(jc)}$	0.9	$^\circ\text{C}/\text{W}$
Mounting torque	to heatsink	$5 \pm 15\%$	Nm
	to terminals	$3 \pm 15\%$	
Weight	$W$	100	g

## Package Outline

(All dimensions in mm)

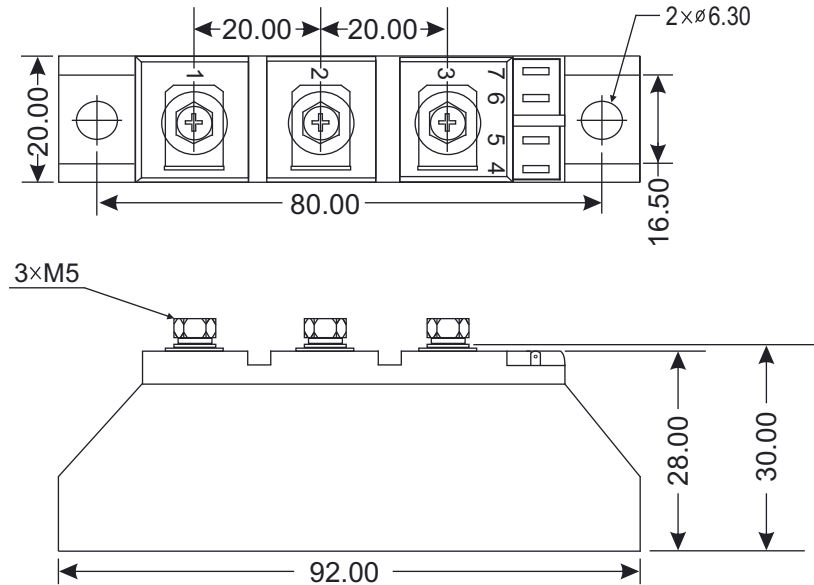

## Circuit Configuration

Circuit Description	Configuration Code	Circuit Drawing
Series Connection (doubler circuit)	N	

## Ordering Table

NTT	27	N	160
1	2	3	4

1 – Power Module

- > DD = Diode-Diode
- > TD = Thyristor-Diode
- > TT = Thyristor-Thyristor

2 – Current Rating =  $I_{T(AV)}$

3 – Circuit Configuration (see Table)

4 – Voltage Code (see Voltage Ratings table)