

## Thyristor-Thyristor Module, 50 Amps

**Features**

- Improved glass passivation for high reliability
- Exceptional stability at high temperatures
- High di/dt and dv/dt capabilities
- Low thermal resistance



Voltage Ratings ( $T_A = 25^\circ\text{C}$ , unless otherwise noted)					
Type number	Voltage Code	$V_{RRM}$ , Maximum repetitive peak reverse voltage (V)	$V_{RSM}$ , Maximum non-repetitive peak reverse voltage (V)	$V_{DRM}$ , Maximum repetitive peak off-state voltage (V)	$I_{RRM}$ , Maximum reverse leakage current @ $T_{JMAX}$ (mA)
NTT57	60	600	700	600	max. 10
	80	800	900	800	
	100	1000	1100	1000	
	120	1200	1300	1200	
	140	1400	1500	1400	
	160	1600	1700	1600	
	180	1800	1900	1800	

Electrical Characteristics ( $T_A = 25^\circ\text{C}$ unless otherwise noted)			
Parameter	Symbol	Values	Units
Maximum average forward current @ $T_J = 85^\circ\text{C}$	$I_{T(AV)}$	50	A
Maximum average RMS forward current	$I_{T(RMS)}$	79	A
Maximum non-repetitive surge current	$I_{TSM}$	1500	A
Maximum $I^2t$ for fusing	$I^2t$	11250	$\text{A}^2\text{s}$
Forward voltage drop	$V_{TM}$	max. 1.6	V
Critical rate of rise of on-state current	di/dt	max. 150	$\text{A}/\mu\text{s}$
Critical rate of rise of off-state voltage	dv/dt	max. 1000	$\text{V}/\mu\text{s}$
Gate current required to trigger	$I_{GT}$	min. 150	mA
Gate voltage required to trigger	$V_{GT}$	min. 3	V
Maximum holding current	$I_H$	150	mA
Maximum latching current	$I_L$	300	mA
Isolation voltage	$V_{ISO}$	3000	V

Thermal & Mechanical Specifications ( $T_A = 25^\circ\text{C}$ unless otherwise noted)			
Parameter	Symbol	Values	Units
Operating junction temperature range	$T_J$	-40 to +125	$^\circ\text{C}$
Storage temperature	$T_{stg}$	-40 to +125	$^\circ\text{C}$
Thermal resistance, junction to case	$R_{th(jc)}$	0.57	$^\circ\text{C}/\text{W}$
Mounting torque	to heatsink	$5 \pm 15\%$	Nm
	to terminals	$3 \pm 15\%$	
Weight	W	100	g

## Package Outline

(All dimensions in mm)

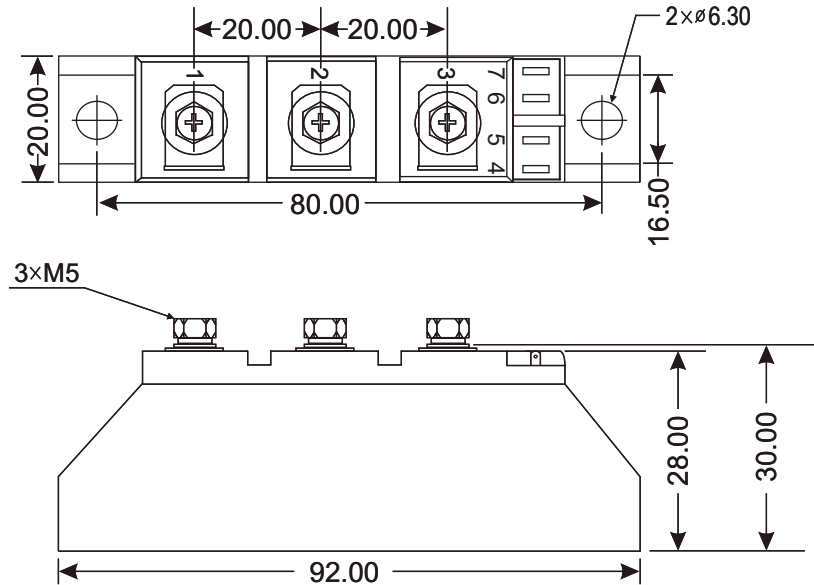

## Circuit Configuration

Circuit Description	Configuration Code	Circuit Drawing
Series Connection (doubler circuit)	N	

## Ordering Table

NTT	57	N	160
1	2	3	4

1 – Power Module

- > DD = Diode-Diode
- > TD = Thyristor-Diode
- > TT = Thyristor-Thyristor

2 – Current Rating =  $I_T(AV)$

3 – Circuit Configuration (see Table)

4 – Voltage Code (see Voltage Ratings table)