

# DATA SHEET

PRODUCTS	<b>Green-Cap</b> (Electric Double Layer Capacitor)
ITEM	DB 2.7V 400F (Ø35 × L60) Part No. DB5U407W35060HA
REMARK	
COMPANY	SAMWHA ELECTRIC
TEL	82-43-261-0200
ADDRESS	3, Bongmyeong-ro, Heungdeok-gu, Cheongju-si, Chungcheongbuk-do, Korea

Approved by *k. c. Eom* 

Technical team manager

- Green-Cap is brand of SAMWHA's electric double layer capacitor(EDLC).
- Electric double layer capacitor(EDLC) is a next generation energy storage device.

## DB5U407W35060HA

Snap-in Terminal Type  
Standard Series

### FEATURE

- Endurance : 2.7V 65°C 2,000hours
- The middle size and high capacitance, low resistance
- Charge and discharge efficiency are higher than in batteries

### DIMENSIONS

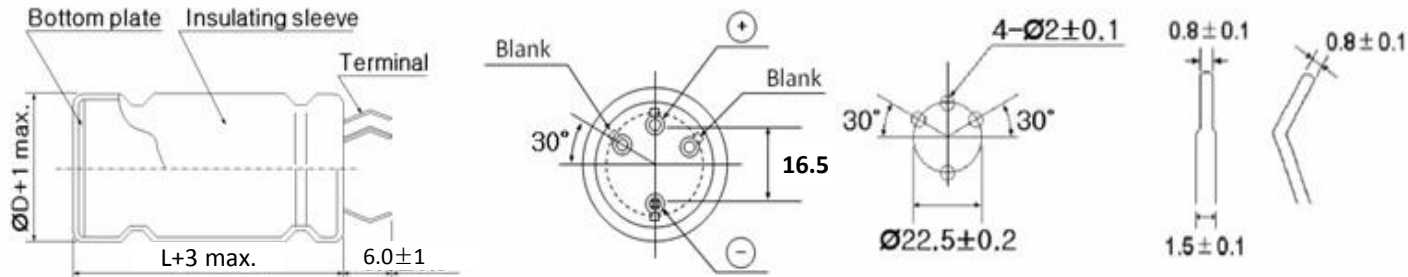

### PRODUCTS SPECIFICATION

Rated Voltage	Capacitance (F)	ESR, 1kHz (mΩ)	ESR, DC (mΩ)	L/C(72hr) (mA Max.)	Specific Energy		Weight (g)	Volume (mℓ)	Dimension $\varnothing D \times L$ (mm)
					(Wh/kg)	(Wh/L)			
2.7	400	3.0	3.2	1.08	5.70	7.02	71	58	35 × 60

## PRODUCTS CHARACTERISTIC

CAPACITANCE	
Nominal Capacitance	400 F
Capacitance tolerance	0 ~ +20 %
VOLTAGE	
Rated voltage	2.7V
Surge voltage	2.85 V
TEMPERATURE	
Operating temperature range	-40~+65 °C
Storage temperature range	-40~+65 °C
Temperature characteristics	
Capacitance change	±5 % (at 20 °C)
Internal resistance change	±50 % (at 20 °C)
RESISTANCE	
AC ESR (1kHz)	3.0 mΩ
DC ESR	3.2 mΩ
CURRENT	
Leakage current After 72hr at 25°C. Initial leakage current can be higher.	1.08 mA
Maximum continuous current	25.4 A
Maximum peak current (1 sec.)	237 A

ENDURANCE	
Endurance After 2,000hr application of rated voltage at 65°C	
Capacitance change	Within ±30% of specified value
Internal resistance change	Within 100% of specified value
Life test After 10 years at rated voltage and 25°C	
Capacitance change	< 30 %
Internal resistance change	< 100 %
CYCLES	
Capacitors cycles between rated voltage under constant current at 25°C (500,000cycles)	
Capacitance change	< 30 %
Internal resistance change	< 100 %
MARKING	
SAMWHA trade mark & series identification	
Rated voltage	
Capacitance value (Marking)	
Sleeve color : Clear blue Print color : Silver	

## PERFORMANCE

Test environmental conditions

- Ambient temperature :  $25 \pm 2^\circ\text{C}$ , Relative humidity : 60~70%, Air pressure : 86~106kPa

No	ITEM	TEST CONDITION	SPECIFICATION															
1	Rated voltage		See the table "PRODUCTS CHARACTERISTIC"															
2	Capacitance (tolerance)	To see measure method (See No. 11)	See the table "PRODUCTS CHARACTERISTIC"															
3	Internal resistance	To see measure method (See No. 12)	See the table "PRODUCTS CHARACTERISTIC"															
4	Leakage current (After 72hr at $25^\circ\text{C}$ )	To see measure method (See No. 13)	See the table "PRODUCTS CHARACTERISTIC"															
5	Temperature characteristics	<table border="1"> <thead> <tr> <th>STEP</th> <th>TEMPERATURE(<math>^\circ\text{C}</math>)</th> <th>TIME</th> </tr> </thead> <tbody> <tr> <td>1</td> <td><math>20 \pm 2</math></td> <td></td> </tr> <tr> <td>2</td> <td><math>-40 \pm 2</math></td> <td>2hr</td> </tr> <tr> <td>3</td> <td><math>20 \pm 2</math></td> <td>15 min</td> </tr> <tr> <td>4</td> <td><math>65 \pm 2</math></td> <td>2 hr</td> </tr> </tbody> </table> <p>Step-1 Capacitance, ESR and leakage current shall be measured.</p> <p>Step-2, 4 After the capacitor being stored for 2hours, capacitance and ESR and leakage current shall be measured.</p> <p>Step-3 After the capacitor being stored for 15min, capacitance and ESR and leakage current shall be measured.</p>	STEP	TEMPERATURE( $^\circ\text{C}$ )	TIME	1	$20 \pm 2$		2	$-40 \pm 2$	2hr	3	$20 \pm 2$	15 min	4	$65 \pm 2$	2 hr	<ul style="list-style-type: none"> <li>• Capacitance change within <math>\pm 5\%</math> of initial value</li> <li>• Internal resistance change <math>\leq 50\%</math> of initial value</li> <li>• Leakage current <math>\leq</math> specified value</li> </ul>
STEP	TEMPERATURE( $^\circ\text{C}$ )	TIME																
1	$20 \pm 2$																	
2	$-40 \pm 2$	2hr																
3	$20 \pm 2$	15 min																
4	$65 \pm 2$	2 hr																
6	Resistance to soldering heat	<ul style="list-style-type: none"> <li>• Solder : HSE-02 SR-34</li> <li>• Flux : 25% by weight of rosin in methanol</li> <li>• Solder temperature : <math>260 \pm 5^\circ\text{C}</math></li> <li>• Immersion depth : 2.0 mm</li> <li>• Immersion speed : <math>25 \pm 2.5</math> mm/sec.</li> </ul>	<ul style="list-style-type: none"> <li>• No visible damage</li> <li>• Capacitance change within <math>\pm 10\%</math> of initial value</li> <li>• Internal resistance change <math>\leq 20\%</math> of initial value</li> <li>• Leakage current <math>\leq</math> specified value</li> </ul>															

## PERFORMANCE

### Test environmental conditions

- Ambient temperature :  $25 \pm 2^\circ\text{C}$ , Relative humidity : 60~70%, Air pressure : 86~106kPa

No	ITEM	TEST CONDITION	SPECIFICATION															
7	Endurance	<ul style="list-style-type: none"> <li>• Temperature : <math>65^\circ\text{C} \pm 2^\circ\text{C}</math></li> <li>• Applied voltage : rated voltage</li> <li>• Duration : 2000 +72/-0 hours</li> </ul>	<ul style="list-style-type: none"> <li>• No visible damage</li> <li>• Capacitance change within <math>\pm 30\%</math> of specified value</li> <li>• Internal resistance change <math>\leq 100\%</math> of specified value</li> <li>• Leakage current <math>\leq</math> specified value</li> </ul>															
8	Shelf life	<ul style="list-style-type: none"> <li>• Temperature : <math>65^\circ\text{C} \pm 2^\circ\text{C}</math></li> <li>• Duration : 2000 +72/-0 hours</li> </ul>	<ul style="list-style-type: none"> <li>• No visible damage</li> <li>• Capacitance change within <math>\pm 30\%</math> of specified value</li> <li>• Internal resistance change <math>\leq 100\%</math> of specified value</li> <li>• Leakage current <math>\leq</math> specified value</li> </ul>															
9	Cycle life	<table border="1"> <thead> <tr> <th>STEP</th> <th>VOLTAGE(V)</th> <th>TIME (sec.)</th> </tr> </thead> <tbody> <tr> <td>1</td> <td>Charge to Rated Voltage</td> <td><math>20 \pm 1</math></td> </tr> <tr> <td>2</td> <td>Rest to Rated Voltage</td> <td><math>10 \pm 0.5</math></td> </tr> <tr> <td>3</td> <td>Discharge to Rated Voltage <math>\times 1/2</math></td> <td>about(<math>20 \pm 1</math>)</td> </tr> <tr> <td>4</td> <td>Rest to Rated Voltage <math>\times 1/2</math></td> <td><math>10 \pm 0.5</math></td> </tr> </tbody> </table> <ul style="list-style-type: none"> <li>• Cycle : 500,000 cycles</li> </ul>	STEP	VOLTAGE(V)	TIME (sec.)	1	Charge to Rated Voltage	$20 \pm 1$	2	Rest to Rated Voltage	$10 \pm 0.5$	3	Discharge to Rated Voltage $\times 1/2$	about( $20 \pm 1$ )	4	Rest to Rated Voltage $\times 1/2$	$10 \pm 0.5$	<ul style="list-style-type: none"> <li>• No visible damage</li> <li>• Capacitance change within <math>\pm 30\%</math> of specified value</li> <li>• Internal resistance change <math>\leq 100\%</math> of specified value</li> <li>• Leakage current <math>\leq</math> specified value</li> </ul>
STEP	VOLTAGE(V)	TIME (sec.)																
1	Charge to Rated Voltage	$20 \pm 1$																
2	Rest to Rated Voltage	$10 \pm 0.5$																
3	Discharge to Rated Voltage $\times 1/2$	about( $20 \pm 1$ )																
4	Rest to Rated Voltage $\times 1/2$	$10 \pm 0.5$																
10	Damp heat (steady state)	<ul style="list-style-type: none"> <li>• Temperature : <math>40 \pm 2^\circ\text{C}</math></li> <li>• Relative humidity : 90%~95%</li> <li>• Duration : <math>240 \pm 8</math> hours</li> </ul>	<ul style="list-style-type: none"> <li>• No visible damage</li> <li>• Capacitance change within <math>\pm 30\%</math> of specified value</li> <li>• Internal resistance change <math>\leq 100\%</math> of specified value</li> <li>• Leakage current <math>\leq</math> specified value</li> </ul>															

## Measuring Method Of Characteristics

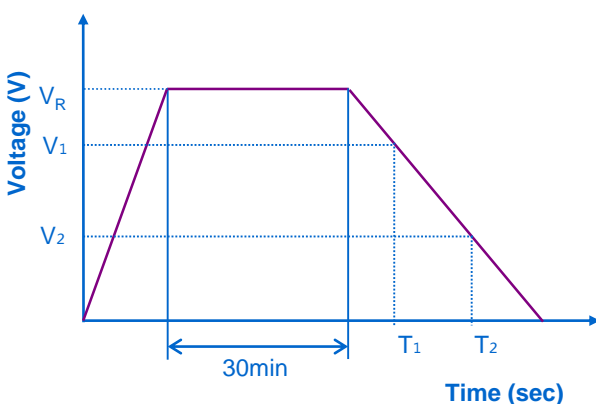
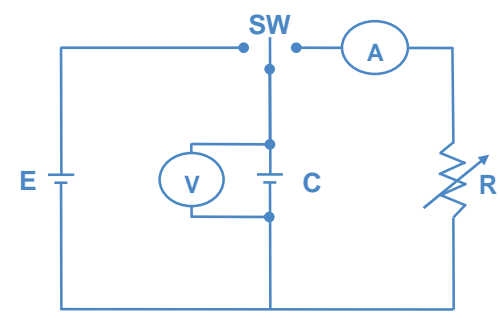
11	Capacitance	<p>1) Charging is performed by constant current followed by constant voltage charging.                  2) Charging is performed for duration of 30 minutes at rated voltage.                  3) Discharge use a constant current load device and measure the time for the terminal voltage to drop from <math>V_1</math> to <math>V_2</math> upon discharge at 1mA/F. (<math>V_1 = 0.8 \times V_R</math>, <math>V_2 = 0.4 \times V_R</math>)                  4) The capacitance can be obtained by the following equation.</p> $C = \frac{I \times (T_2 - T_1)}{V_1 - V_2} \text{ (F)}$  
12	ESR	<p>The AC Resistance is used.</p> <ol style="list-style-type: none"> <li>1) The Frequency of the measuring voltage shall be 1kHz.</li> <li>2) The AC current shall be from 1 to 10mA.</li> </ol>
13	Leakage current	<ol style="list-style-type: none"> <li>1) Charging is performed by constant current followed by constant voltage charging</li> <li>2) Charging is performed for duration of 72 hours at rated voltage.</li> <li>3) Then, Leakage current is measured by current measurement equipment.</li> </ol>

• Please contact SAMWHA Green-Cap directly for any technical specifications critical to application.

## Dimensions

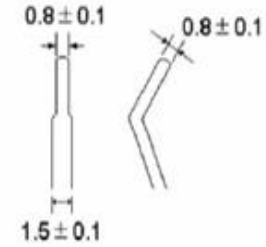
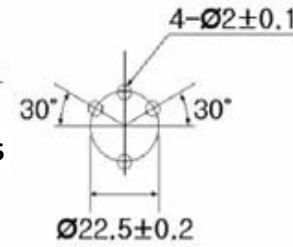
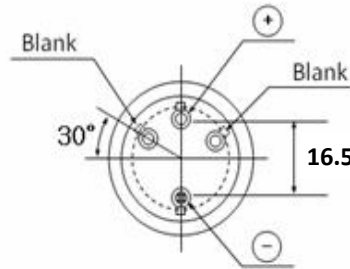
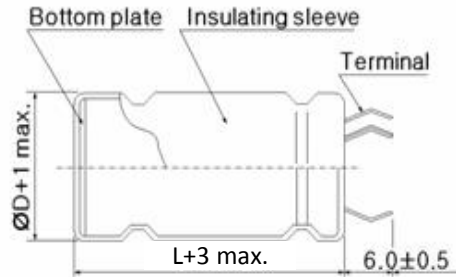

14

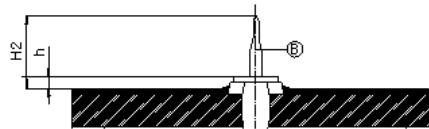
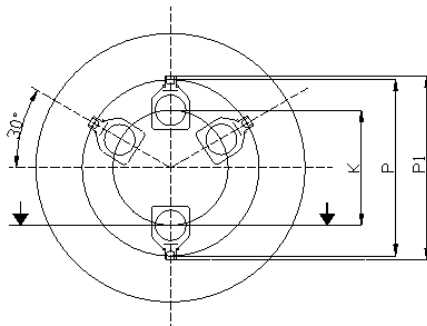

P	P1	K	H2	h
$\pm 1.0$	$\pm 0.5$	$\pm 0.2$	$\pm 0.3$	Max.
22.5	24.3	16.5	8.1	1.2

• Please contact SAMWHA Green-Cap directly for any technical specifications critical to application.