

DATA SHEET

PRODUCTS	Green-Cap (Electric Double Layer Capacitor)
ITEM	DK 2.7V 400F (Ø35 × L60) Part No. DK5U407W35060HA
REMARK	
COMPANY	SAMWHA ELECTRIC
TEL	82-43-261-0200
ADDRESS	3, Bongmyeong-ro, Heungdeok-gu, Cheongju-si, Chungcheongbuk-do, Korea

Approved by *k. c. Eom*



Technical team manager

- Green-Cap is brand of SAMWHA's electric double layer capacitor(EDLC).
- Electric double layer capacitor(EDLC) is a next generation energy storage device.

DK5U407W35060HA

Snap-in Terminal Type
Standard Series

FEATURE

- Endurance : 2.7V 85°C 1,500hours
- The middle size and high capacitance, low resistance
- Charge and discharge efficiency are higher than in batteries

DIMENSIONS

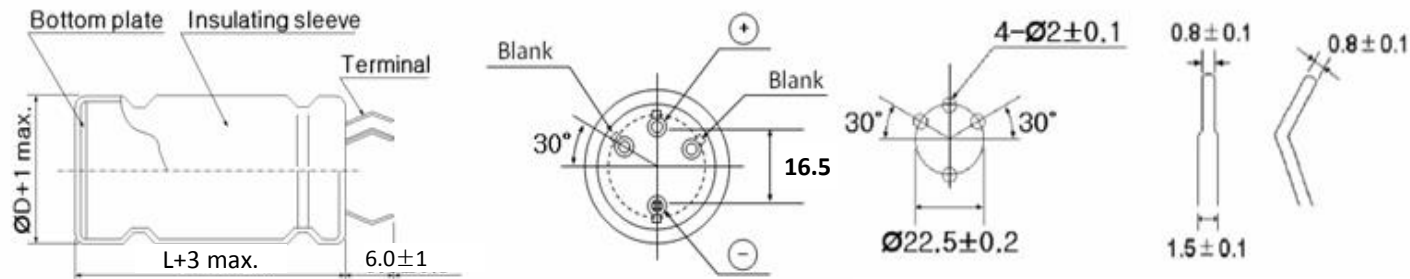

PRODUCTS SPECIFICATION

Rated Voltage	Capacitance (F)	ESR, 1kHz (mΩ)	ESR, DC (mΩ)	L/C(72hr) (mA Max.)	Specific Energy		Weight (g)	Volume (mℓ)	Dimension $\varnothing D \times L$ (mm)
					(Wh/kg)	(Wh/L)			
2.7	400	3.2	3.8	1.08	5.70	7.02	71	58	35 × 60

PRODUCTS CHARACTERISTIC

CAPACITANCE	
Nominal Capacitance	400 F
Capacitance tolerance	0 ~ +20 %
VOLTAGE	
Rated voltage	2.7V
Surge voltage	2.85 V
TEMPERATURE	
Operating temperature range	-40~+85 °C
Storage temperature range	-40~+85 °C
Temperature characteristics	
Capacitance change	±5 % (at 20 °C)
Internal resistance change	±50 % (at 20 °C)
RESISTANCE	
AC ESR (1kHz)	3.2 mΩ
DC ESR	3.8 mΩ
CURRENT	
Leakage current After 72hr at 25°C. Initial leakage current can be higher.	1.08 mA
Maximum continuous current	25.1 A
Maximum peak current (1 sec.)	214 A

ENDURANCE	
Endurance After 1,500hr application of rated voltage at 85°C	
Capacitance change	Within ±30% of specified value
Internal resistance change	Within 100% of specified value
Life test After 10 years at rated voltage and 25°C	
Capacitance change	< 30 %
Internal resistance change	< 100 %
CYCLES	
Capacitors cycles between rated voltage under constant current at 25°C (500,000cycles)	
Capacitance change	< 30 %
Internal resistance change	< 100 %
MARKING	
SAMWHA trade mark & series identification	
Rated voltage	
Capacitance value (Marking)	
Sleeve color : Clear blue Print color : Silver	

PERFORMANCE

Test environmental conditions

- Ambient temperature : $25\pm 2^{\circ}\text{C}$, Relative humidity : 60~70%, Air pressure : 86~106kPa

No	ITEM	TEST CONDITION	SPECIFICATION															
1	Rated voltage		See the table "PRODUCTS CHARACTERISTIC"															
2	Capacitance (tolerance)	To see measure method (See No. 11)	See the table "PRODUCTS CHARACTERISTIC"															
3	Internal resistance	To see measure method (See No. 12)	See the table "PRODUCTS CHARACTERISTIC"															
4	Leakage current (After 72hr at 25°C)	To see measure method (See No. 13)	See the table "PRODUCTS CHARACTERISTIC"															
5	Temperature characteristics	<table border="1"> <thead> <tr> <th>STEP</th> <th>TEMPERATURE($^{\circ}\text{C}$)</th> <th>TIME</th> </tr> </thead> <tbody> <tr> <td>1</td> <td>20 ± 2</td> <td></td> </tr> <tr> <td>2</td> <td>-40 ± 2</td> <td>2hr</td> </tr> <tr> <td>3</td> <td>20 ± 2</td> <td>15 min</td> </tr> <tr> <td>4</td> <td>85 ± 2</td> <td>2 hr</td> </tr> </tbody> </table> <p>Step-1 Capacitance, ESR and leakage current shall be measured.</p> <p>Step-2, 4 After the capacitor being stored for 2hours, capacitance and ESR and leakage current shall be measured.</p> <p>Step-3 After the capacitor being stored for 15min, capacitance and ESR and leakage current shall be measured.</p>	STEP	TEMPERATURE($^{\circ}\text{C}$)	TIME	1	20 ± 2		2	-40 ± 2	2hr	3	20 ± 2	15 min	4	85 ± 2	2 hr	<ul style="list-style-type: none"> • Capacitance change within $\pm 5\%$ of initial value • Internal resistance change $\leq 50\%$ of initial value • Leakage current \leq specified value
STEP	TEMPERATURE($^{\circ}\text{C}$)	TIME																
1	20 ± 2																	
2	-40 ± 2	2hr																
3	20 ± 2	15 min																
4	85 ± 2	2 hr																
6	Resistance to soldering heat	<ul style="list-style-type: none"> • Solder : HSE-02 SR-34 • Flux : 25% by weight of rosin in methanol • Solder temperature : $260 \pm 5^{\circ}\text{C}$ • Immersion depth : 2.0 mm • Immersion speed : 25 ± 2.5 mm/sec. 	<ul style="list-style-type: none"> • No visible damage • Capacitance change within $\pm 10\%$ of initial value • Internal resistance change $\leq 20\%$ of initial value • Leakage current \leq specified value 															

PERFORMANCE

Test environmental conditions

- Ambient temperature : 25±2°C, Relative humidity : 60~70%, Air pressure : 86~106kPa

No	ITEM	TEST CONDITION	SPECIFICATION															
7	Endurance	<ul style="list-style-type: none"> • Temperature : 85°C ±2°C • Applied voltage : rated voltage • Duration : 1500 +72/-0 hours 	<ul style="list-style-type: none"> • No visible damage • Capacitance change within ±30% of specified value • Internal resistance change ≤ 100% of specified value • Leakage current ≤ specified value 															
8	Shelf life	<ul style="list-style-type: none"> • Temperature : 85°C ±2°C • Duration : 1500 +72/-0 hours 	<ul style="list-style-type: none"> • No visible damage • Capacitance change within ±30% of specified value • Internal resistance change ≤ 100% of specified value • Leakage current ≤ specified value 															
9	Cycle life	<table border="1"> <thead> <tr> <th>STEP</th> <th>VOLTAGE(V)</th> <th>TIME (sec.)</th> </tr> </thead> <tbody> <tr> <td>1</td> <td>Charge to Rated Voltage</td> <td>20 ± 1</td> </tr> <tr> <td>2</td> <td>Rest to Rated Voltage</td> <td>10 ± 0.5</td> </tr> <tr> <td>3</td> <td>Discharge to Rated Voltage ×1/2</td> <td>about(20 ± 1)</td> </tr> <tr> <td>4</td> <td>Rest to Rated Voltage ×1/2</td> <td>10 ± 0.5</td> </tr> </tbody> </table> <ul style="list-style-type: none"> • Cycle : 500,000 cycles 	STEP	VOLTAGE(V)	TIME (sec.)	1	Charge to Rated Voltage	20 ± 1	2	Rest to Rated Voltage	10 ± 0.5	3	Discharge to Rated Voltage ×1/2	about(20 ± 1)	4	Rest to Rated Voltage ×1/2	10 ± 0.5	<ul style="list-style-type: none"> • No visible damage • Capacitance change within ±30% of specified value • Internal resistance change ≤ 100% of specified value • Leakage current ≤ specified value
STEP	VOLTAGE(V)	TIME (sec.)																
1	Charge to Rated Voltage	20 ± 1																
2	Rest to Rated Voltage	10 ± 0.5																
3	Discharge to Rated Voltage ×1/2	about(20 ± 1)																
4	Rest to Rated Voltage ×1/2	10 ± 0.5																
10	Damp heat (steady state)	<ul style="list-style-type: none"> • Temperature : 40±2°C • Relative humidity : 90%~95% • Duration : 240±8 hours 	<ul style="list-style-type: none"> • No visible damage • Capacitance change within ±30% of specified value • Internal resistance change ≤ 100% of specified value • Leakage current ≤ specified value 															

Measuring Method Of Characteristics

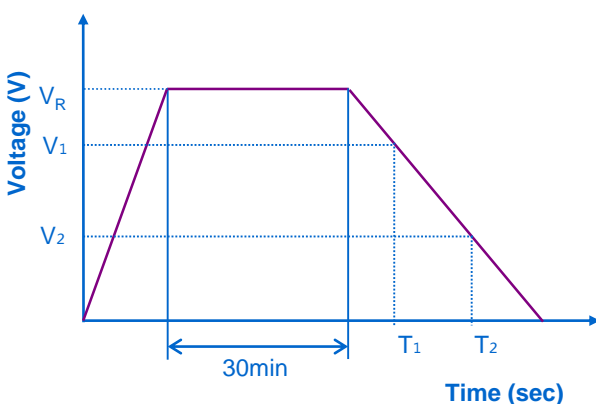
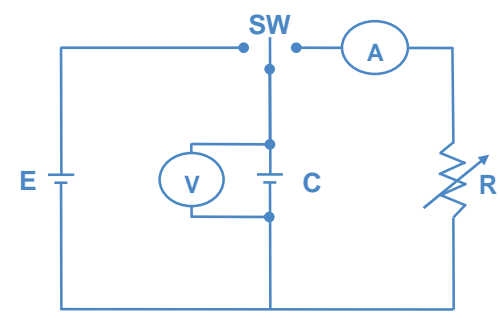
11	Capacitance	<p>1) Charging is performed by constant current followed by constant voltage charging. 2) Charging is performed for duration of 30 minutes at rated voltage. 3) Discharge use a constant current load device and measure the time for the terminal voltage to drop from V_1 to V_2 upon discharge at 1mA/F. ($V_1 = 0.8 \times V_R$, $V_2 = 0.4 \times V_R$) 4) The capacitance can be obtained by the following equation.</p> $C = \frac{I \times (T_2 - T_1)}{V_1 - V_2} \text{ (F)}$  
12	ESR	<p>The AC Resistance is used. 1) The Frequency of the measuring voltage shall be 1kHz. 2) The AC current shall be from 1 to 10mA.</p>
13	Leakage current	<p>1) Charging is performed by constant current followed by constant voltage charging 2) Charging is performed for duration of 72 hours at rated voltage. 3) Then, Leakage current is measured by current measurement equipment.</p>

• Please contact SAMWHA Green-Cap directly for any technical specifications critical to application.

Dimensions

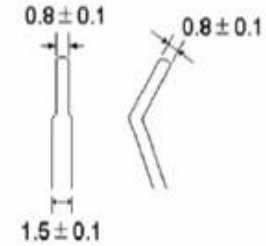
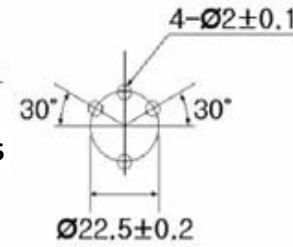
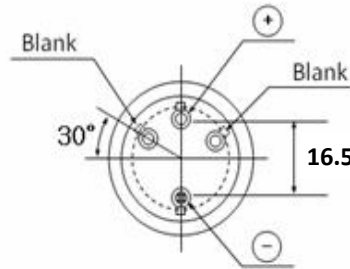
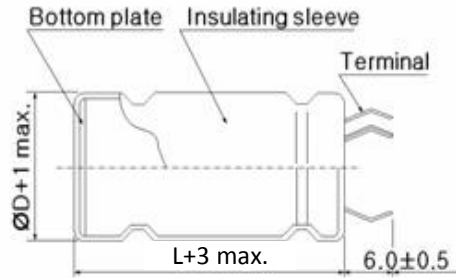

14

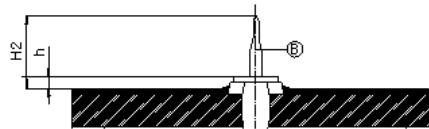
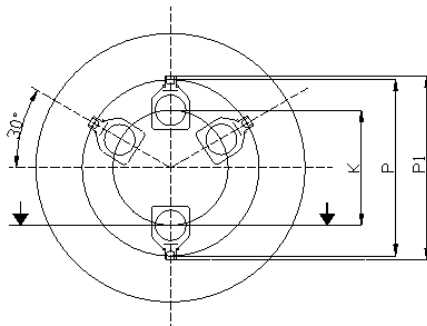

P	P1	K	H2	h
± 1.0	± 0.5	± 0.2	± 0.3	Max.
22.5	24.3	16.5	8.1	1.2

• Please contact SAMWHA Green-Cap directly for any technical specifications critical to application.