

Schottky Power Diode, 60A

Features

- Fast Switching
- Low forward voltage drop
- High surge capability
- High efficiency, low power loss
- Normal and Reverse polarity



DO-203AB (DO-5)

Maximum Ratings ($T_J = 25^\circ\text{C}$, unless otherwise noted)							
Parameter	Test Conditions	Symbol	MBR6045(R)	MBR6060(R)	MBR6080(R)	MBR60100(R)	
Repetitive peak reverse voltage		V_{RRM}	45	60	80	100	V
RMS reverse voltage		V_{RMS}	32	42	57	70	V
DC blocking voltage		V_{DC}	45	60	80	100	V
Continuous forward current	$T_C \leq 100^\circ\text{C}$	I_F	60	60	60	60	A
Surge non-repetitive forward current, half-sine wave	$T_C = 25^\circ\text{C}$	I_{FSM}	700	700	700	700	A
Forward voltage	$I_F = 60\text{ A}$ $T_J = 25^\circ\text{C}$	V_F	0.65	0.75	0.84	0.84	V
Reverse current	$V_R = 20\text{ V}$, $T_J = 25^\circ\text{C}$	I_R	5	5	5	5	mA
	$V_R = 20\text{ V}$, $T_J = 125^\circ\text{C}$		150	150	150	150	

Thermal & Mechanical Specifications ($T_J = 25^\circ\text{C}$, unless otherwise noted)						
Parameters	Symbol	MBR6045(R)	MBR6060(R)	MBR6080(R)	MBR60100(R)	Unit
Maximum thermal resistance, junction to case	$R_{th(jc)}$	1.0				$^\circ\text{C/W}$
Operating junction temperature range	T_J	-65 to 150				$^\circ\text{C}$
Storage temperature	T_{stg}	-65 to 175				$^\circ\text{C}$
Mounting torque (non-lubricated threads)	F	4.0				Nm
Approximate allowable weight	W	17.0				g

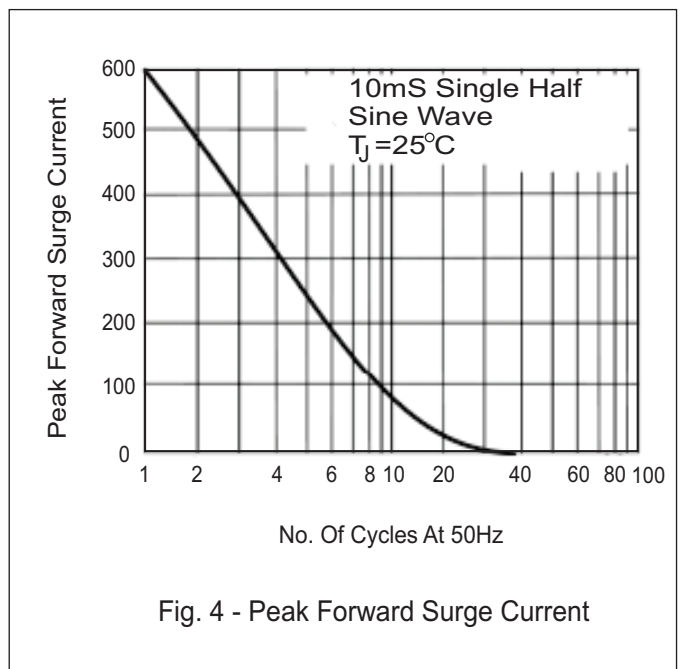
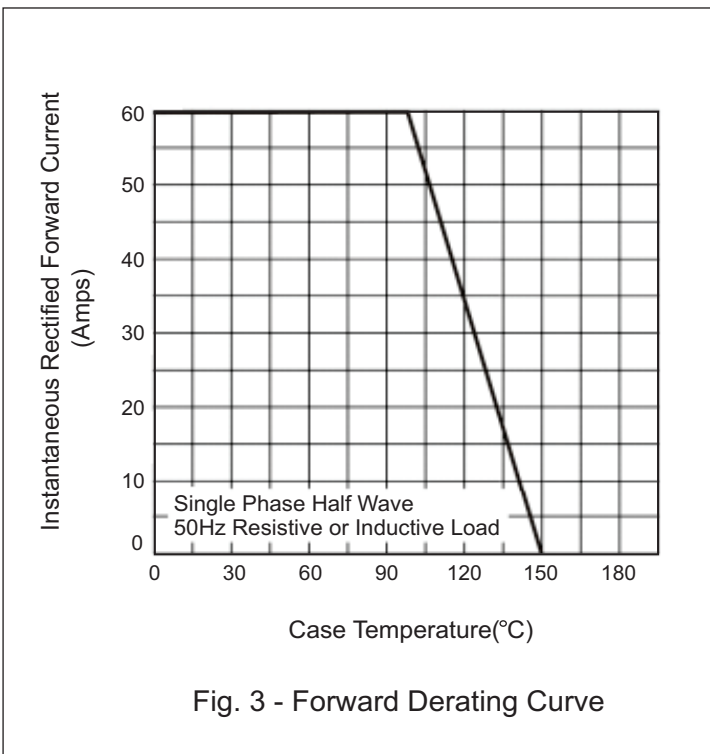
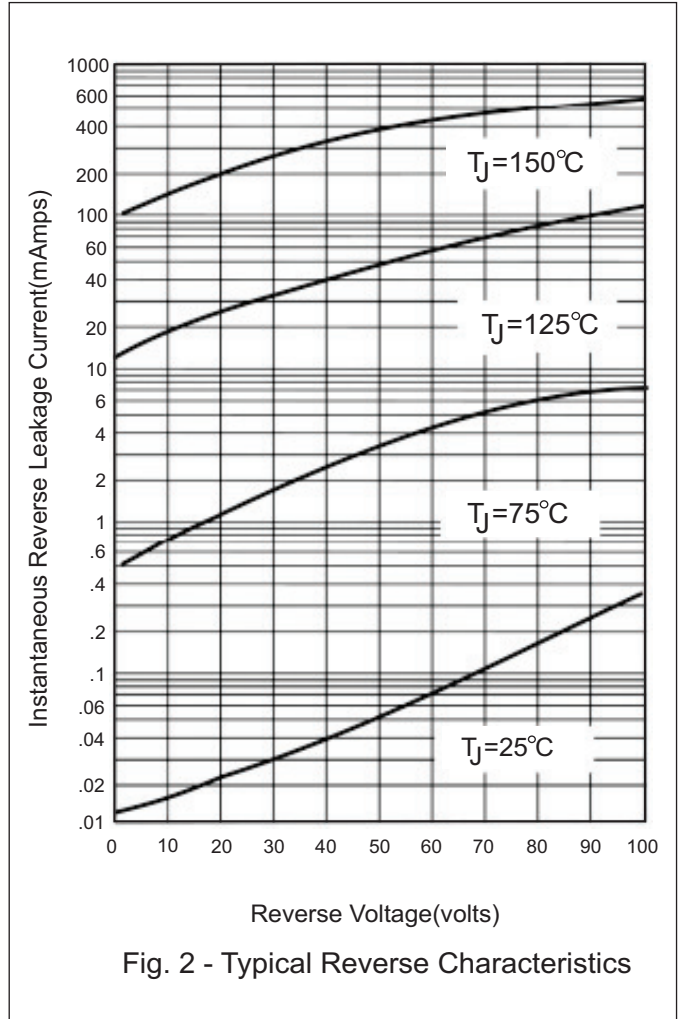
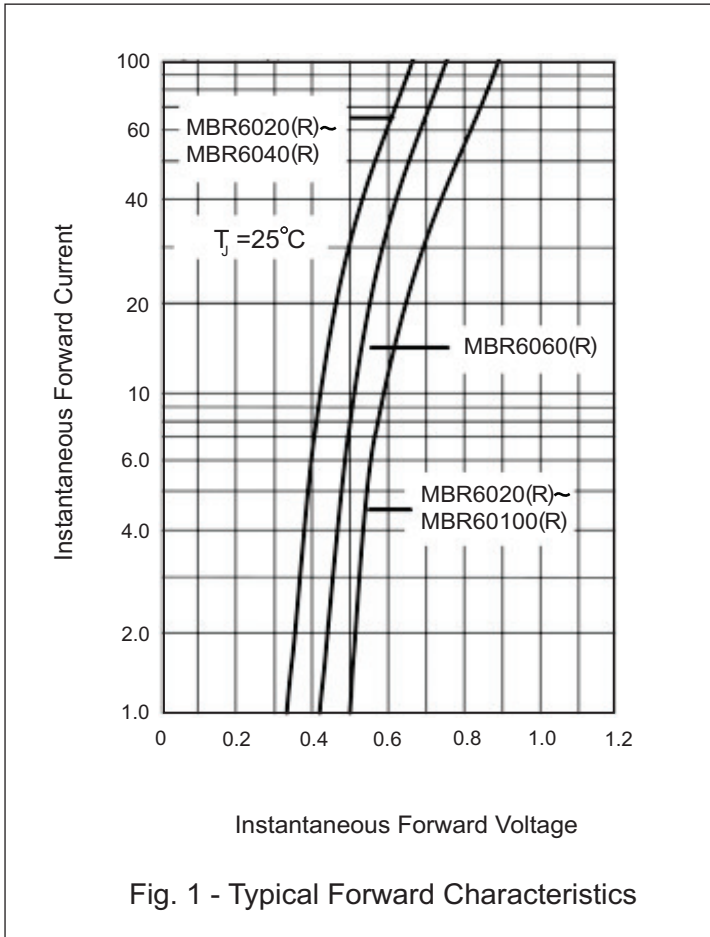

Package Outline

DO-203AB (DO-5)

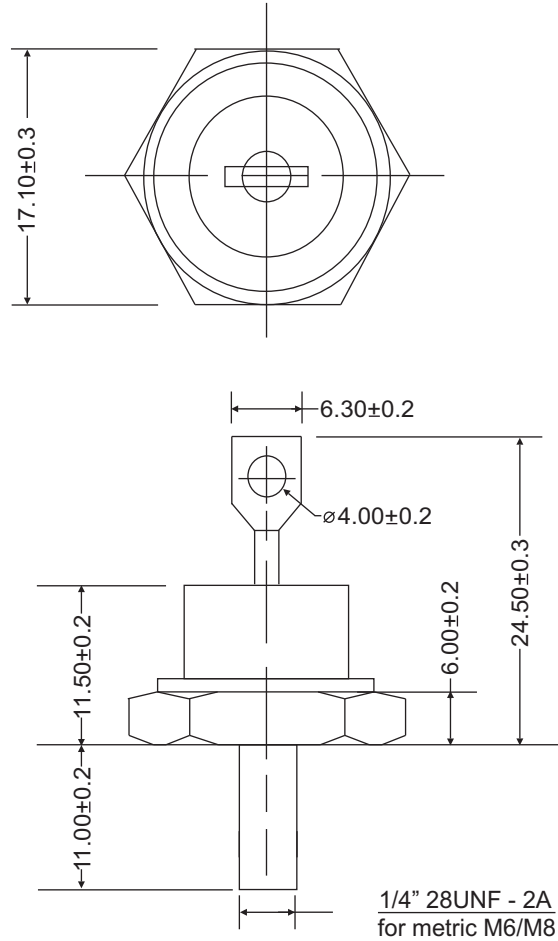

ALL DIMENSIONS IN MM